

ATLANTA

8X--AT 1R

1 / 12

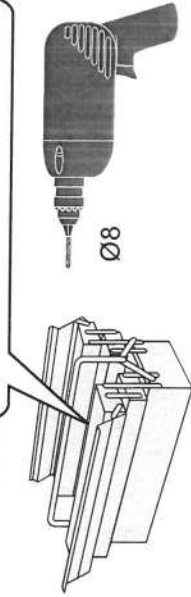
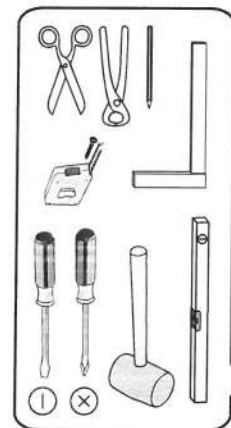
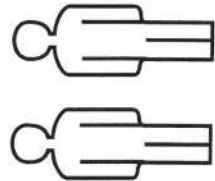

8X--AT 1R

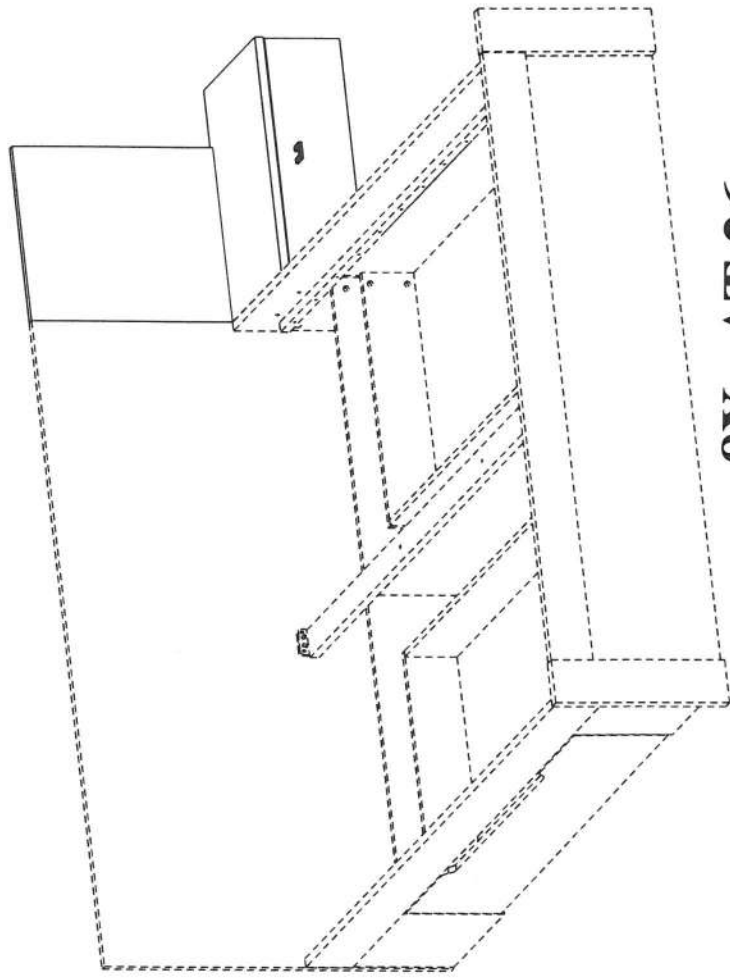
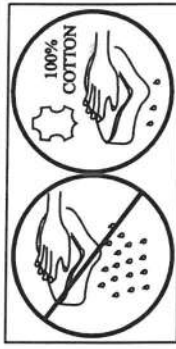
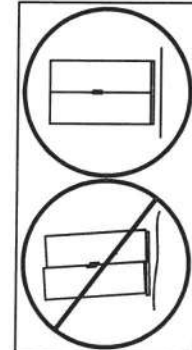
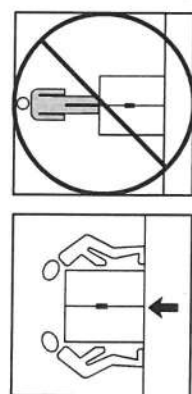
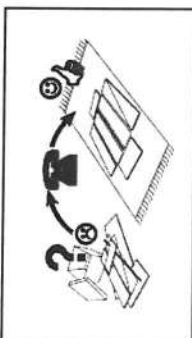
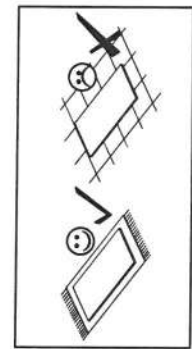
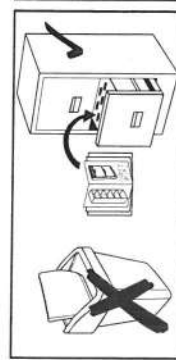

8X--AT 26





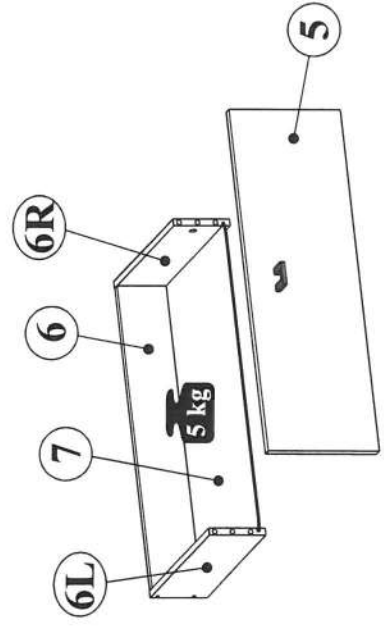
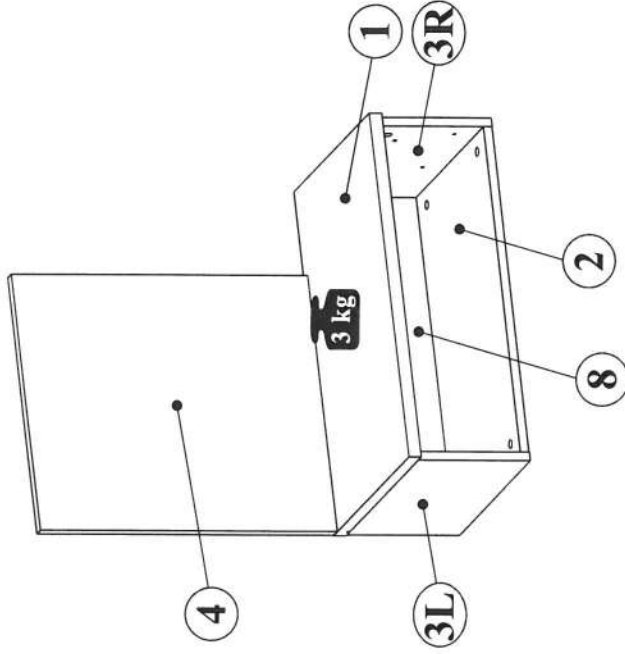
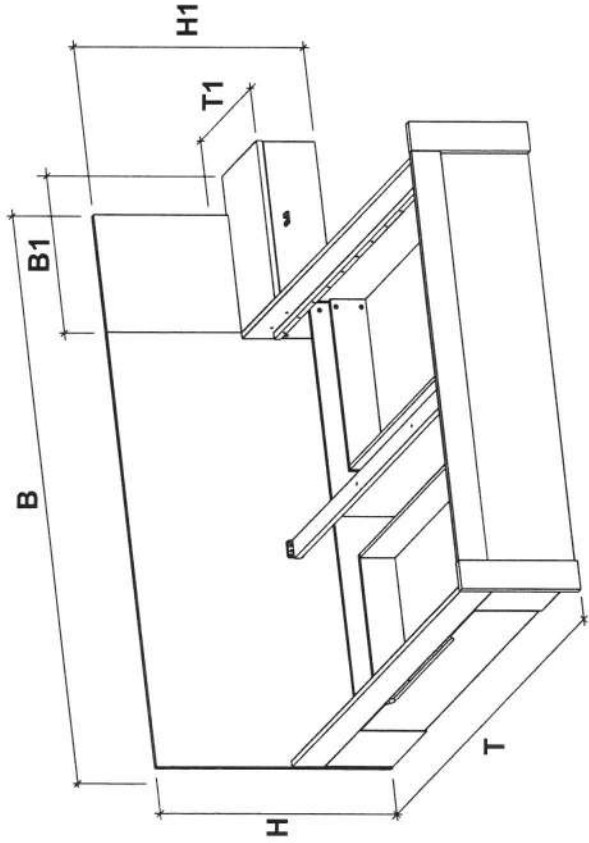

B - 2318mm
 H - 900mm
 T - 2066mm

B1 - 600mm
 H1 - 738mm
 T1 - 380mm





1	600x380	1	1/1
2	568x361	1	1/1
3L,3R	198x362	2	1/1
4	447x518	1	1/1
5	596x194	1	1/1
6L,6R	302x100	2	1/1
6	528x100	1	1/1
7	539x300	1	1/1
8	577x191	1	1/1







NR 1

B1  φ 8x28 x10	M1  φ15x12mm x8	T1  5x39mm x8	K7  7x70 x3	A19  M6x35 x2	G11  x2	J23  x6
---	--	--	--	--	---	---



NR 2

F59  110x50x1.5 x2	P11  4x13 x16	C18  5mm x4
---	--	--

NR 3

Q30B  L-300mm x1L/1R	E2  6,0x8 x4	S3  3,5x13 x4	M2  φ12x10mm x2	T2  5x35mm x2	P5  4x30 x4
--	--	---	--	--	--

NR 4

U173  x1	A2  M4x25 x2
--	---

C 1/1



ATLANTA

8X--AT 1R

4 / 12

1

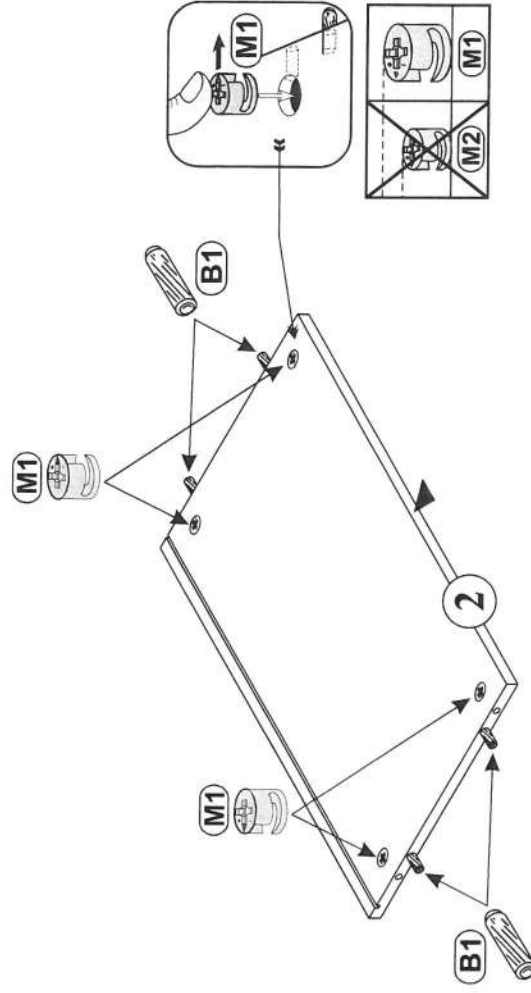
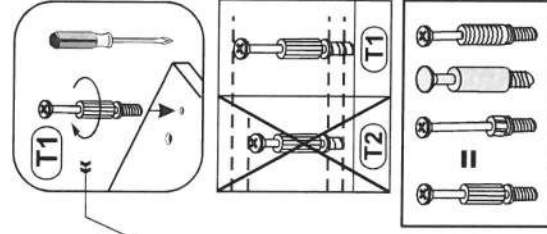
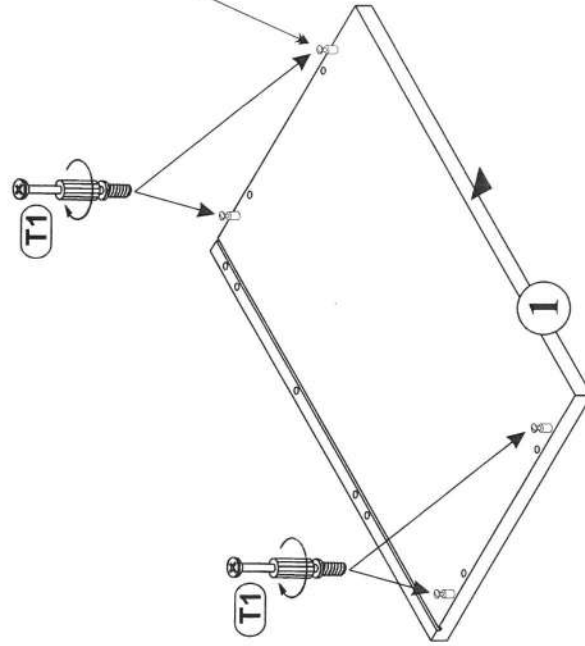

2

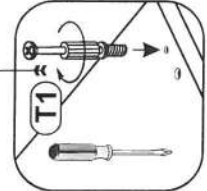
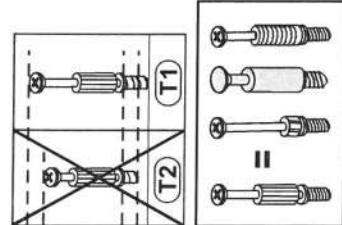
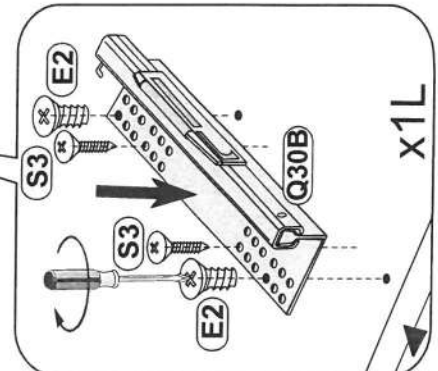
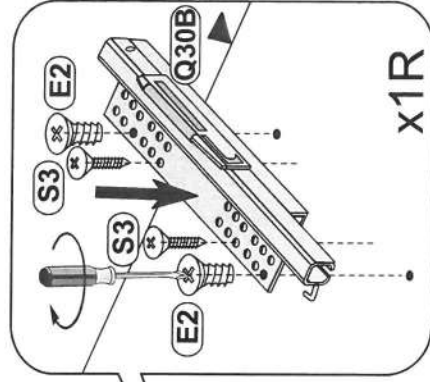
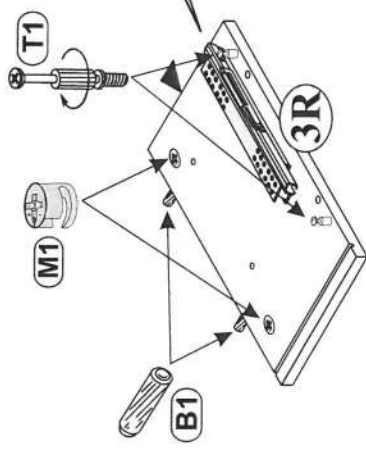
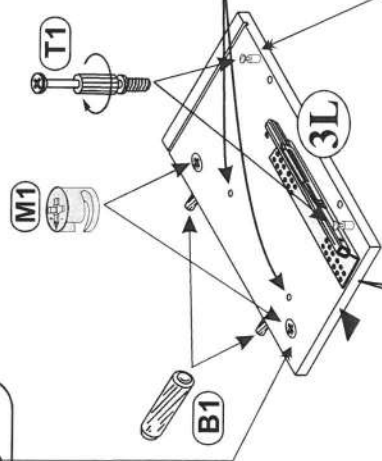
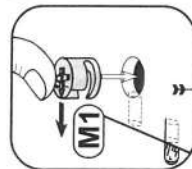
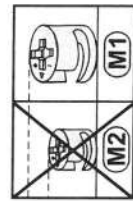
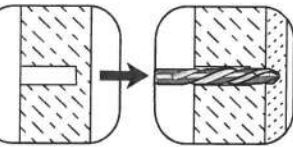
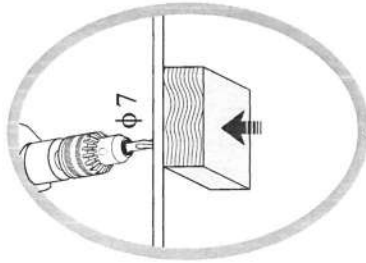
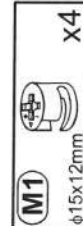
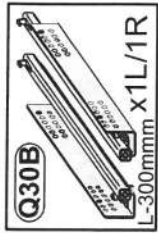

3

- (F59)** 110x50x1,5 x2
- (P11)** 4x13 x8

- (B1)** ϕ 8x28 x2

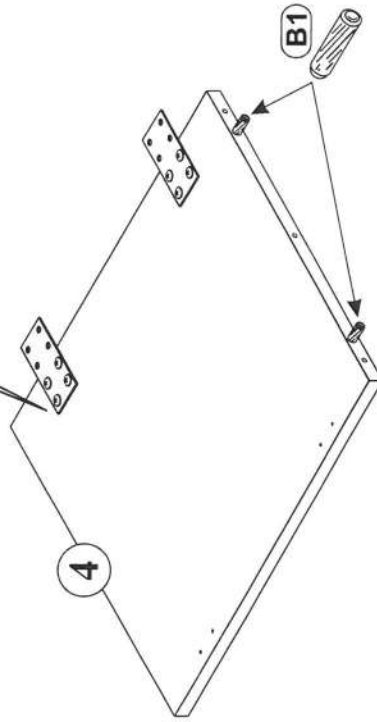
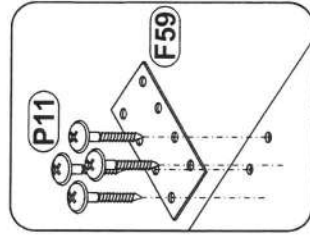

4

- (K7)** 7x70 x3

- (G7)** S4 x1

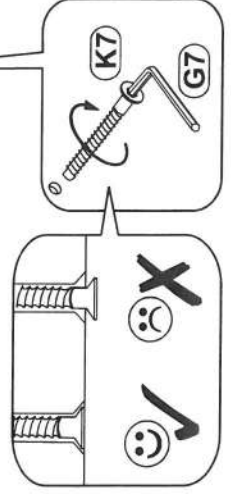
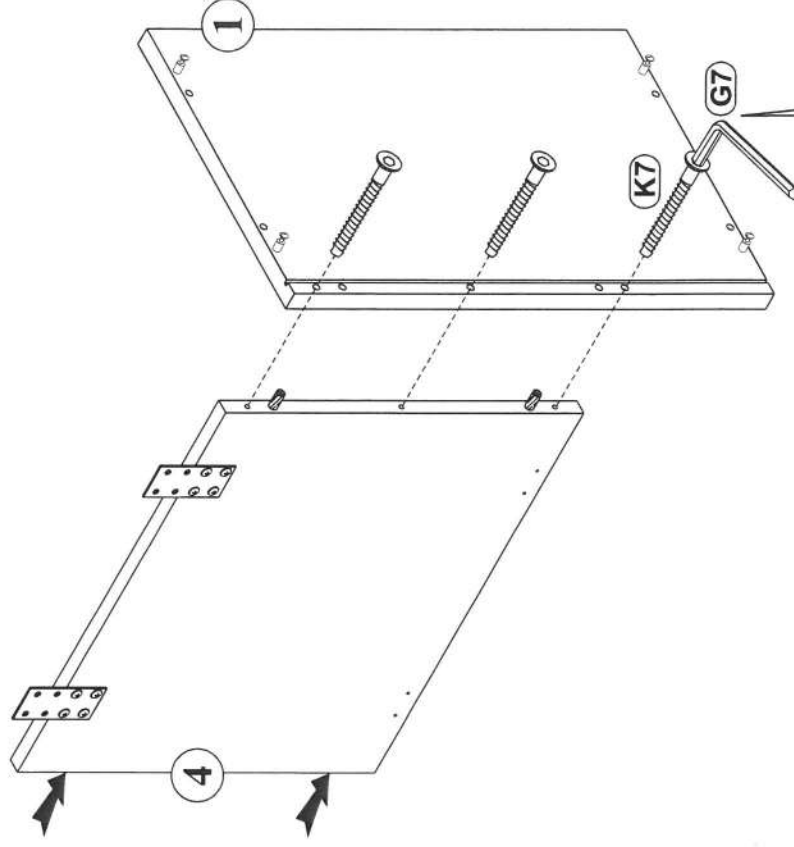
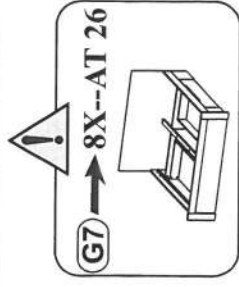

5

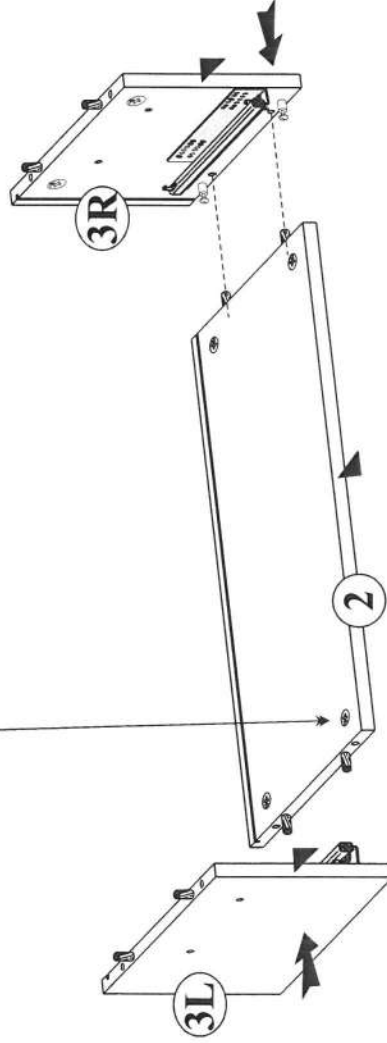
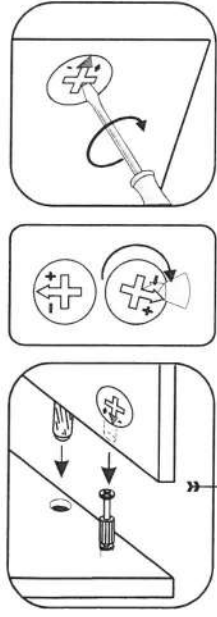

6

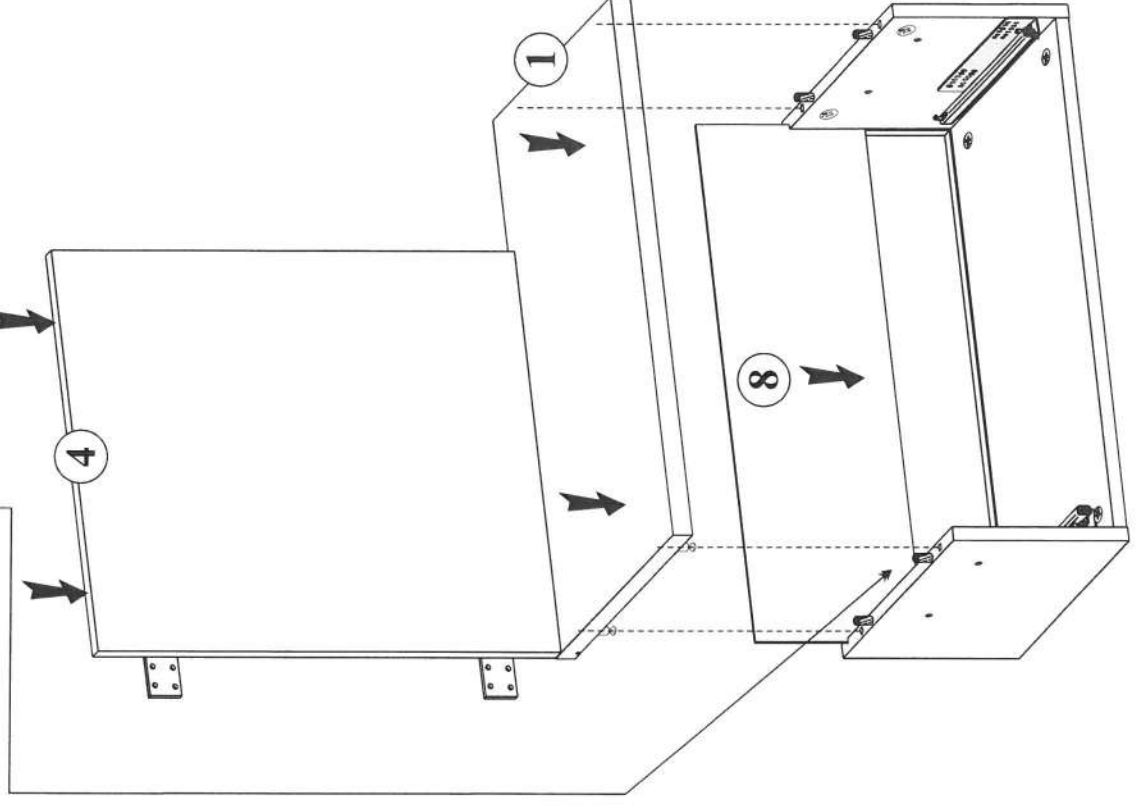
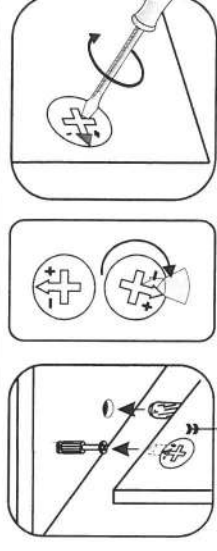

7

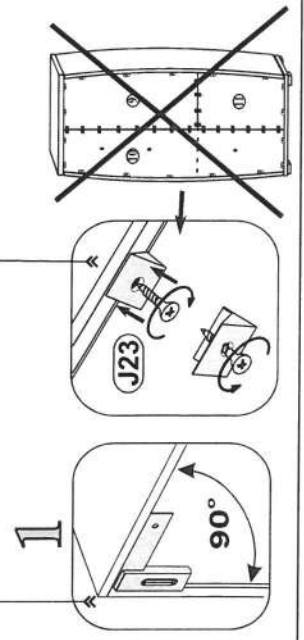
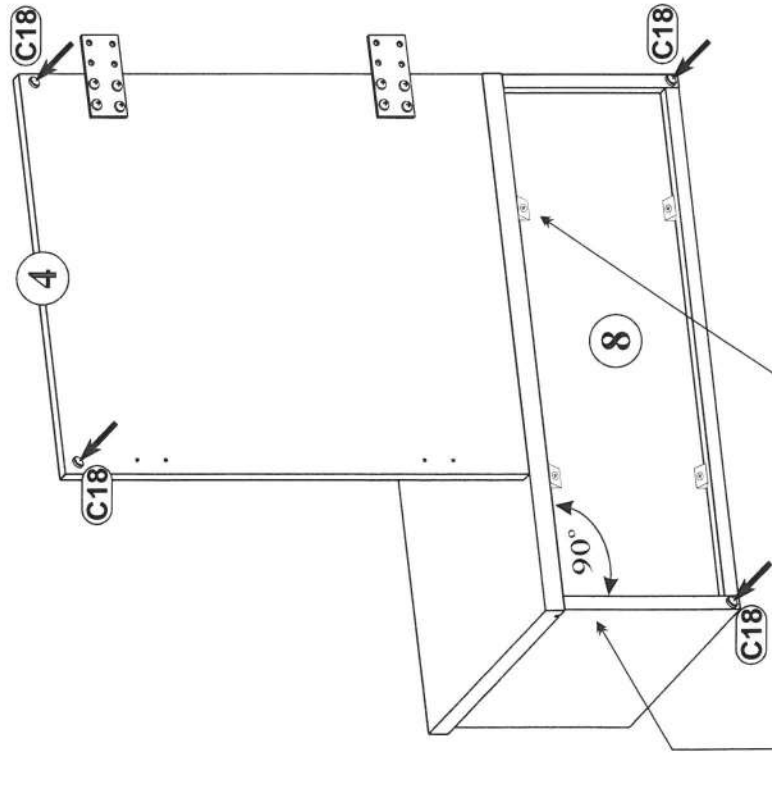
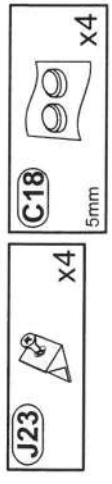

8

8X--AT 26

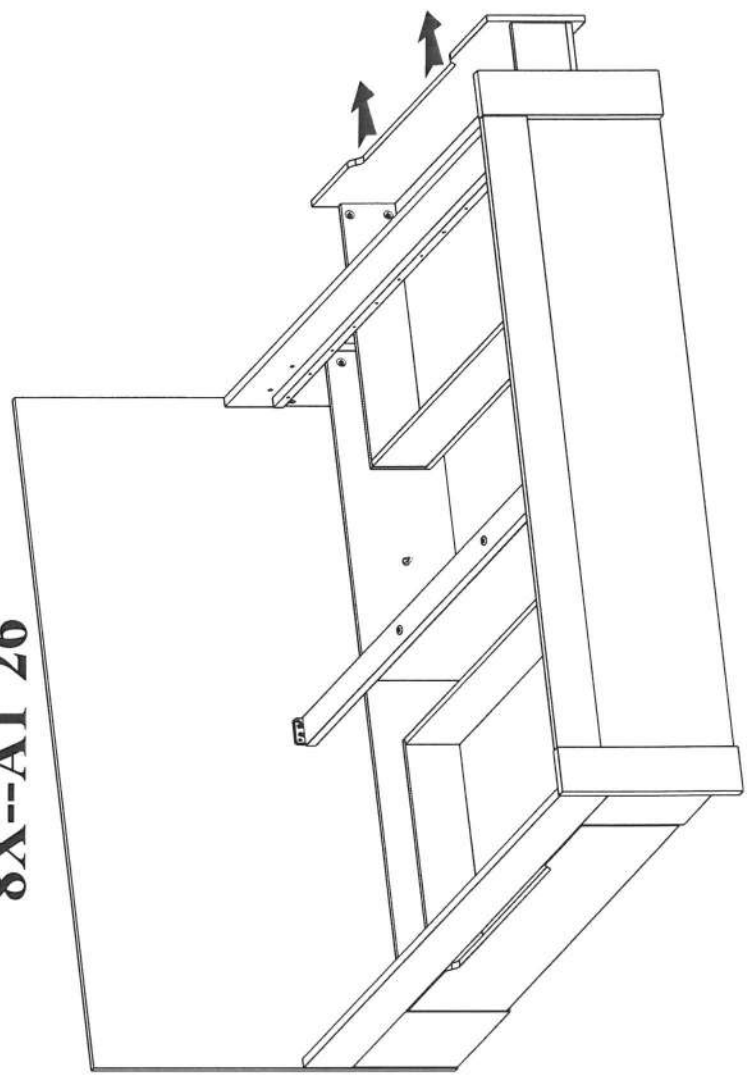

9

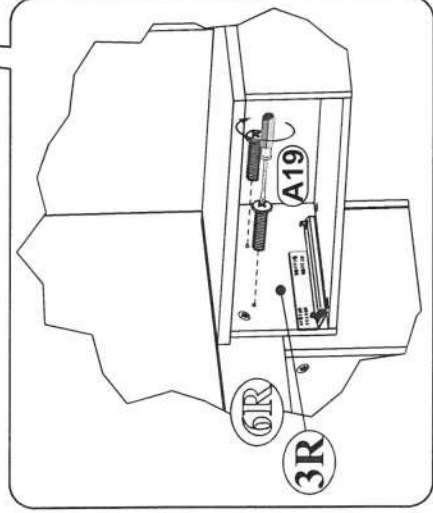
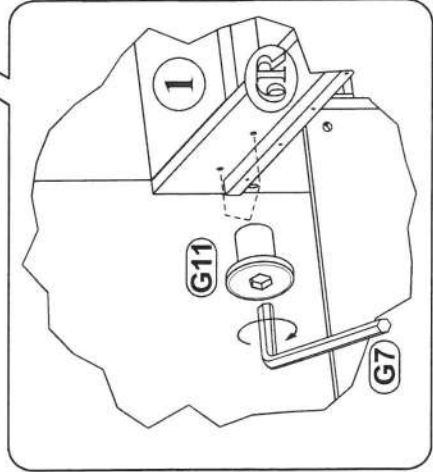
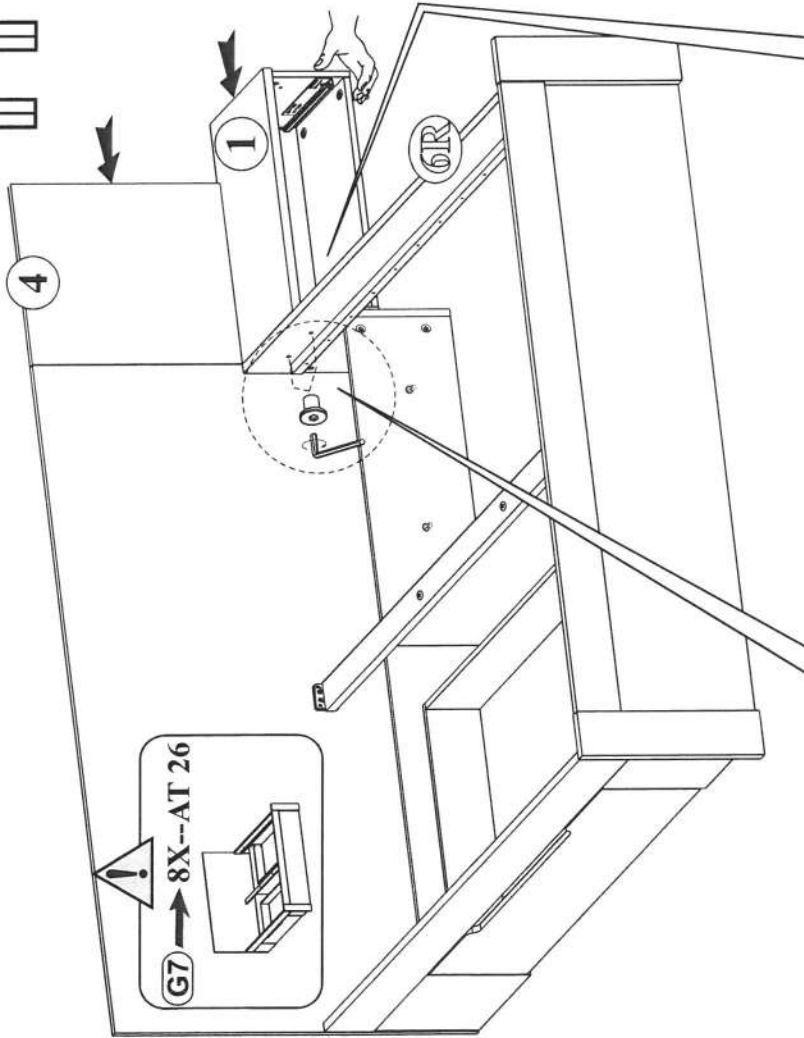
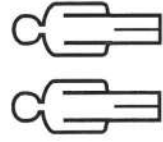
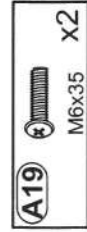

10

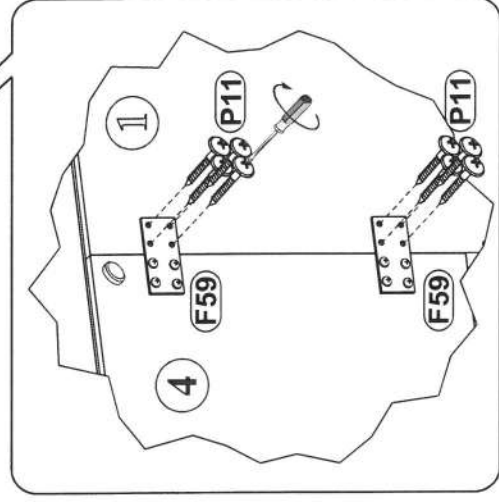
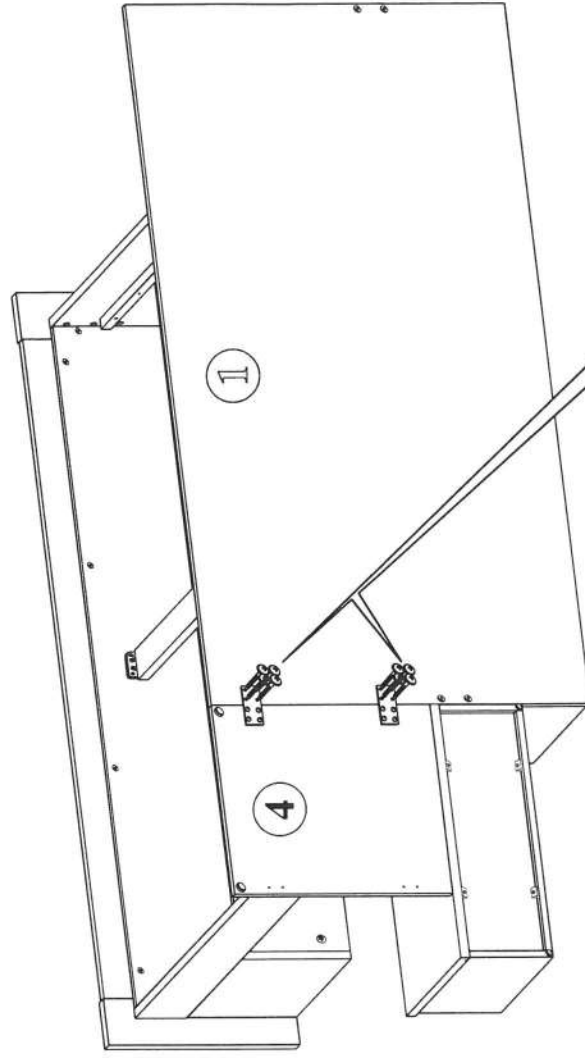
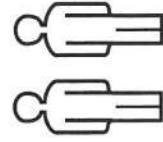

11

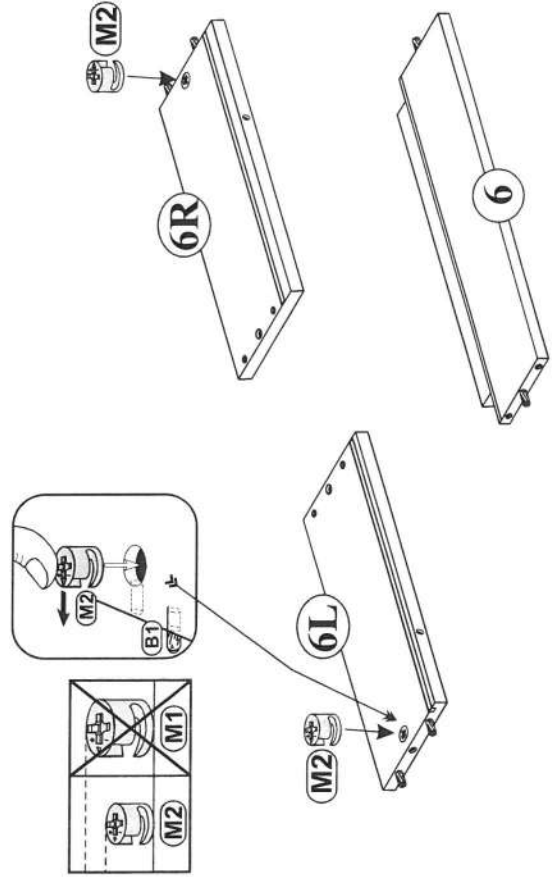
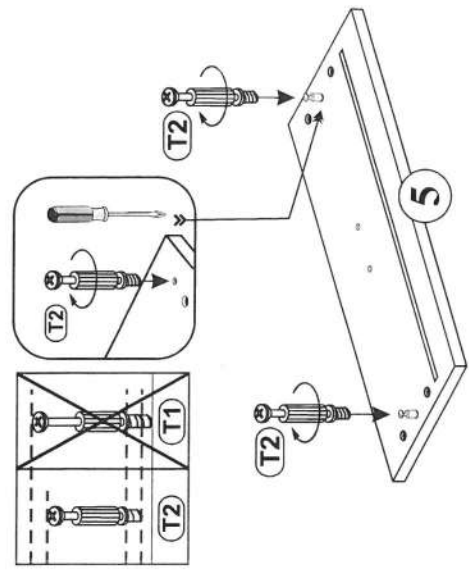

- (M2) $\phi 12 \times 10 \text{mm}$ x2
- (T2) $5 \times 32 \text{mm}$ x2

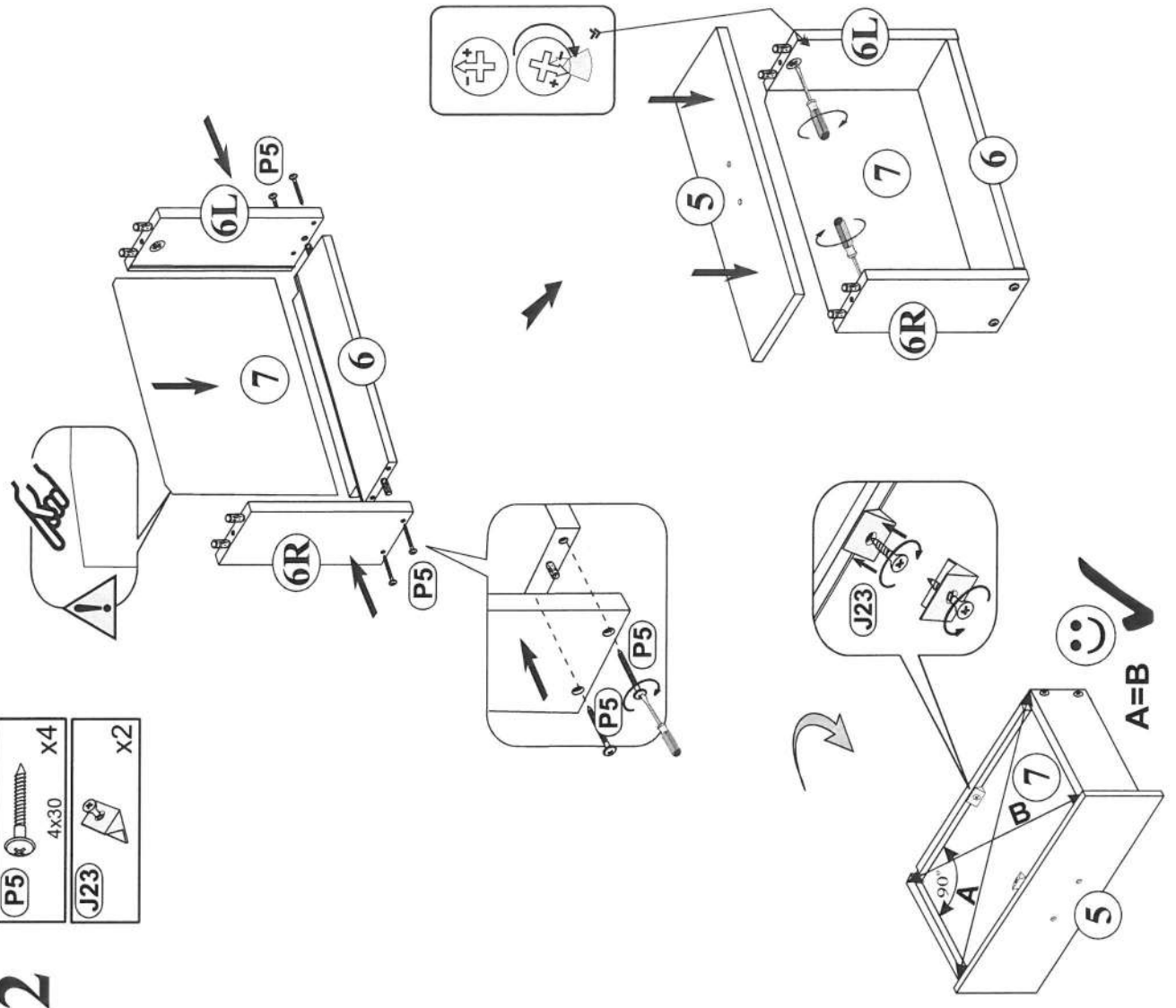

12

- (P5) 4×30 x4
- (J23) x2



-  U173 x1
-  A2 M4x25 x2

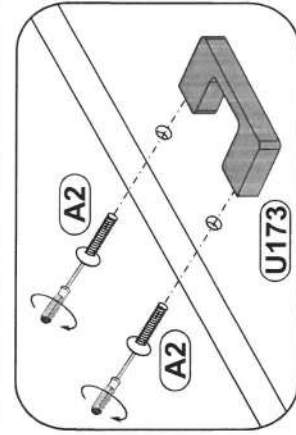

13

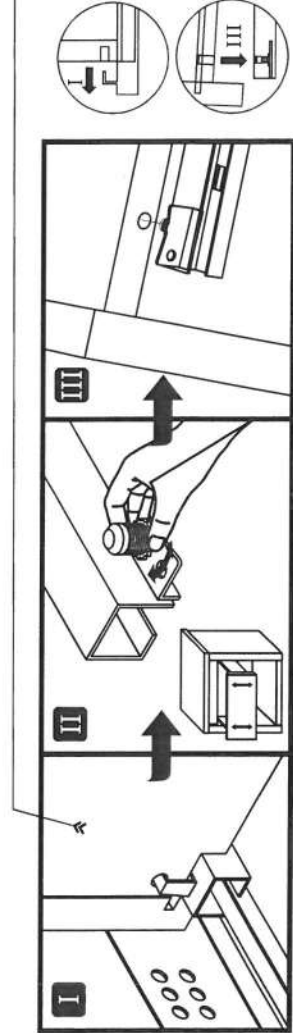
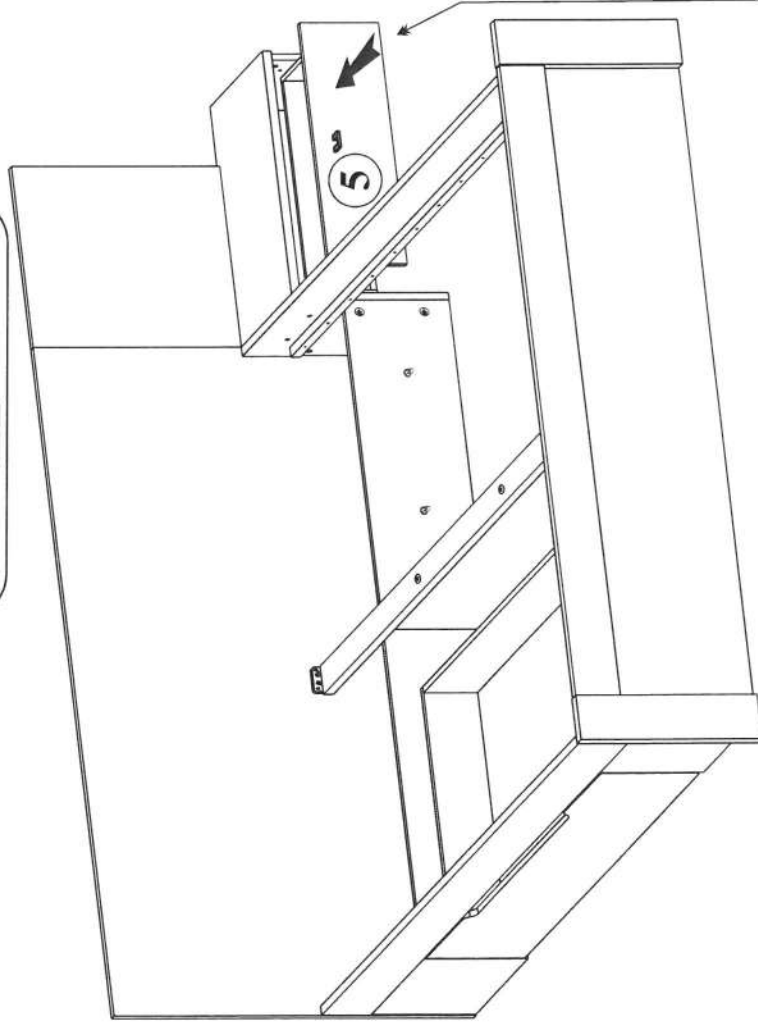

14

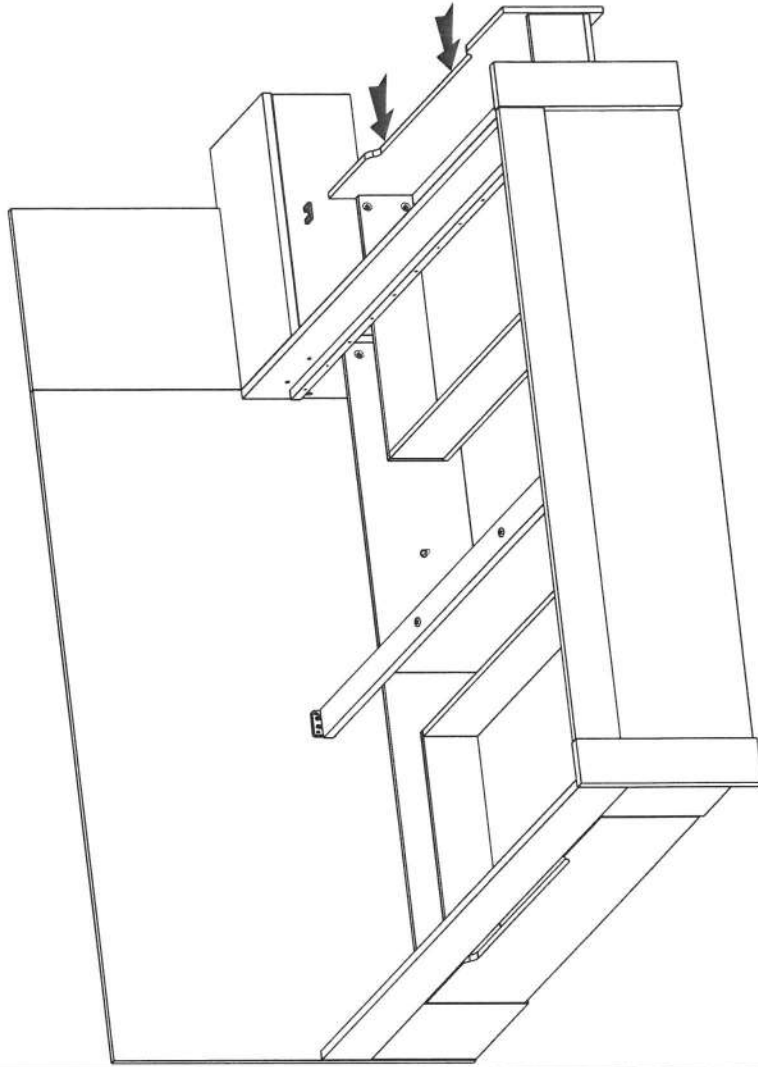

15

